



The Cimarron

Pontoon Boat

O W N E R ' S M A N U A L



TABLE OF CONTENTS

INTRODUCTION	3
PRODUCT SPECIFICATIONS & CAPACITY	4
SAFETY INFORMATION AND SYMBOLS	5
RESPONSIBILITIES OF THE OPERATOR(S)	6
INFLATION	7
PARTS LIST	9
ASSEMBLY AND USE	10-13
REPAIR AND TROUBLESHOOTING	14-15
CARE AND STORAGE	16
CLEAN ANGLER STATEMENT	17
WARRANTY	20

INTRODUCTION

Congratulations on your purchase of a Classic Accessories pontoon boat.

This manual has been compiled to help you assemble your boat correctly and operate it safely. It contains specific details of the boat, including its parts and equipment, and information on its safe operation, proper care, maintenance and repair. Please read it carefully, and familiarize yourself with your boat before using it.

If this is your first pontoon boat, or if you are changing to this type of boat for the first time, for your own comfort and safety, please ensure that you obtain handling and operating experience before serious use. Doing so will assure many years of trouble free use and enjoyment.

PLEASE KEEP THESE INSTRUCTIONS IN A SECURE PLACE, AND TRANSFER THEM TO THE NEW OWNER IF YOU SELL THE CRAFT.

MODIFICATIONS

Because of possible interference with the factory design and integrity of the boat, owner modifications to the boat, any of its parts, equipment or systems are not recommended.

Classic does not recommend that owners modify the boat or any of its parts, equipment or systems. Such modifications could compromise the design and integrity of the boat, prevent safe operation, and void warranty coverage.

PRODUCT SPECIFICATIONS & CAPACITY

BOAT SPECIFICATIONS

Product Name: CIMARRON Pontoon Boat

Dimensions: 96 in L x 54 in W x 29 in H (top of the seat)
244 cm L x 137 cm W x 74 cm H (top of the seat)

Dry Weight: 37.5 lbs (17 kg)

Maximum Persons Capacity: 1 person or up to 275 lbs (125 kg)

Maximum Persons & Gear Capacity: 350 lbs (159 kg)

Recommended Inflation Pressure: 2.5 psi (0.17 BAR)

BOAT CAPACITY

The person/load capacity is partly dependent on proper seating and load distribution. Make sure that your load is distributed evenly and the seating position is such that, when afloat, the boat rides level in the water.

⚠ WARNING - DO NOT EXCEED THE MAXIMUM CAPACITY OF THIS BOAT UNDER ANY CIRCUMSTANCES.

MAXIMUM CAPACITIES

1 PERSON OR 275 LBS.

350 LBS PERSONS, GEAR

PRESSURE = 2.5 psi (main chambers)

THIS BOAT IS NOT RATED FOR PROPULSION BY A MOTOR

MANUFACTURER: CLASSIC ACCESSORIES, INC.,
KENT, WA, USA 98032

1  +  = 159 kg

 •  = 0.17 bar (main chambers)

SAFETY INFORMATION AND SYMBOLS

 The symbol to the left is the Safety Alert symbol. It is used to alert you to potential personal injury hazards. Obey all safety messages that follow this symbol to avoid possible injury or death.

DANGER

Indicates a potentially hazardous situation which, if not avoided, will result in death or serious injury.

WARNING

Indicates a potentially hazardous situation which, if not avoided, could result in death or serious injury.

CAUTION

Indicates a potentially hazardous situation which, if not avoided, may result in minor or moderate injury.

CAUTION

Indicates a potentially hazardous situation which, if not avoided, may result in property damage.

This manual lists certain recommended practices and provides some basic precautions. However, this list of precautions is not all-inclusive. Users must follow all applicable laws, rules, and regulations and should exercise appropriate caution in the safe operation of this pontoon boat.

REMEMBER - always use common sense when using your pontoon boat.

RESPONSIBILITIES OF THE OPERATOR(S)

IMPORTANT SAFETY AND CARE INFORMATION

- Read this owner's manual carefully before using your pontoon boat.
- This is not a life saving device.
- You **MUST** wear an approved personal flotation device (PFD).
- All safety equipment & PFDs must properly fit the user, be in good condition, and suitable for your body weight.
- Know and follow all local water safety rules and boating regulations.
- Do not exceed 350 lbs (159 kg) total cargo weight. (The weight of you and all of your gear should not exceed 350 lbs (159 kg)).
- Inspect your pontoon boat for wear or damage before and after each use.
- This product is not to be used by children under the age of 16 years of age or by any child without adult supervision. Check the laws in your state.
- Always use a Coast Guard approved personal flotation device.
- Never float alone.
- Never use this boat in bad weather.
- Keep sharp objects (knives, fish hooks, etc.) away from the pontoons.
- Not for use by children or as pool toy.
- Do not use under the influence of drugs or alcohol.
- Do not tow this pontoon boat.
- Use only in water free from debris and obstructions.
- Do not use in high wind, rapid currents, open water or dangerous tides.
- Seek shelter from water if there is threat of lightning.
- Do not stand on this product while in use.
- Never dive into or from this boat.
- Inflate with cold air only.
- Do not over inflate or use CO₂ or a high pressure air compressor to inflate.
- Follow the inflation sequence listed in this instruction manual.
- Recommended working pressure is 2.5 psi (0.17 bar). **DO NOT EXCEED 2.5 PSI.**
- Check for leaks before using.
- Partially deflate if leaving boat in direct sunlight or within a vehicle in sunlight.
- Remember that air pressure changes with temperature and elevation so always check your air pressure before use.
- Check all screws and wingnuts before each use.

CARE

- Clean with warm water and a mild detergent.
- To avoid mildew be sure your boat is dry before storing it.
- Deflate pontoons slightly between uses to extend the life of your boat.

INFLATION

PROPER INFLATION

During final inflation, inflate until most of the wrinkles in the fabric are gone and it feels firm to the touch, but DO NOT exceed 2.5 psi (0.17 bar) in the main air chambers.

CAUTION - DO NOT OVER INFLATE YOUR PONTOON BOAT

Water temperature and weather affect the air pressure in the boat. In cold weather your pontoon boat will lose some pressure because the air will contract. If this occurs, you may want to add more air.

In hot weather, the air will expand. You must let out some air to prevent the pontoons from failing from over pressure. Avoid exposing your pontoon boat to extreme temperatures (hot or cold).

CAUTION

On warm sunny days, keep the pontoon boat either in water or in shade (if kept inflated on land). This will decrease the risk of overexpansion of the pontoon chambers posed by rising temperatures, which can result in seam tears, delamination and pinholes.

Avoid asphalt, sand, pebbles or concrete in direct sunlight as they radiate high ground heat.

Also understand that changes in altitude will cause the air in the bladders to expand or contract. If traveling to higher elevation with the pontoon boat inflated, frequently check the pressure in the pontoons to avoid over pressure. If traveling to lower elevation you may have to add more air to maintain proper pressure in the pontoons.

 WARNING - ALWAYS CHECK THE AIR PRESSURE IN THE PONTOONS BEFORE AND DURING EACH USE.

ASSEMBLY AND USE

It is important to follow these instructions to successfully and safely assemble your Classic Accessories Pontoon Boat.

Please pay particular attention to the bold faced instructions and any information which has this  symbol next to it.

CIMARRON PONTOON BOAT PARTS LIST

Before you begin please unpack the carton and check that you have all your parts.

IMPORTANT: All small parts are located inside the center pocket of one of the storage bags marked by a tag for easy identification.

Tools Needed: Rubber Mallet

Small Parts (Small parts bag located in pontoon pocket)

- 2 Pontoon Bladder Patches
(Two 60mm self-adhesive patches)



- 1 Inflation Adapter



- 1 Inflation Valve Wrench



- 2 Oarlocks
- 2 Oarlock Cotter Pins

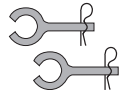

- 2 Long Frame Clevis Pins
- 8 Short Frame Clevis Pins

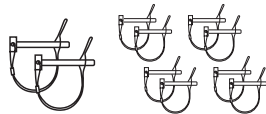

- 1 Foam Flypatch
(pre-installed on left pontoon skin)

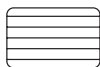

Oar Parts

- 2 Two-piece Oars

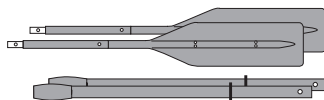

Metal Frame Parts

- 2 Pontoon Side Frames

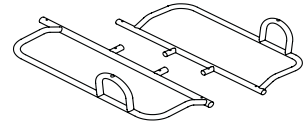

- 1 Seat Frame

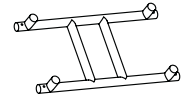

- 2 Foot Pegs

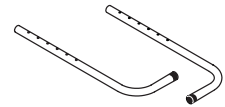

- 1 Cargo Deck Frame

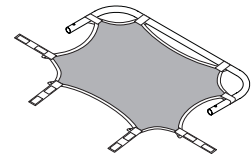

- 1 Cargo Deck
(partially assembled)

- 2 Seat Base Frames
- 1 Seat Base
(assembled)

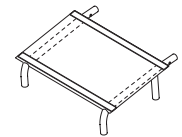

- 1 Seat Back Frame
- 1 Seat Back
- 2 Seat Back Frame Stubs

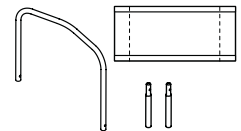

Soft Parts:

- 2 Pontoon Skins
(left and right)

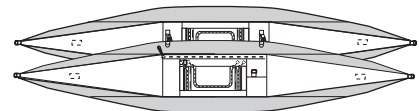

- 1 Stripping Apron

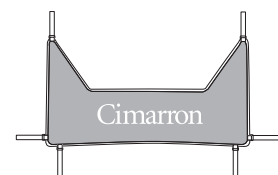

ASSEMBLY AND USE

1. Confirm that all the parts are present.

(See the parts list on page 9).

2. Identify the right and left pontoons.

You can identify the right and left pontoons by the “R” (right) and “L” (left) labels sewn on the inside of the pocket on top of each.

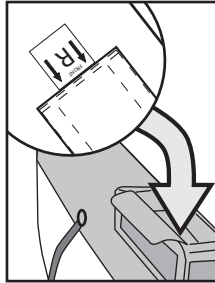

The inflation valves are located on the top of the pontoons in front of the main pocket.

Each valve has a center button that opens and closes the valve by simply pushing down, and turning a quarter turn. The valve is open when the center button is down and closed when it is up.

Before inflating, make sure the valve is in the closed position.

Unscrew the valve cap, make sure the valve is closed and insert the inflation adapter into the valve and twist to secure. Inflate using a foot pump or air compressor with a cone-type nozzle fitting.

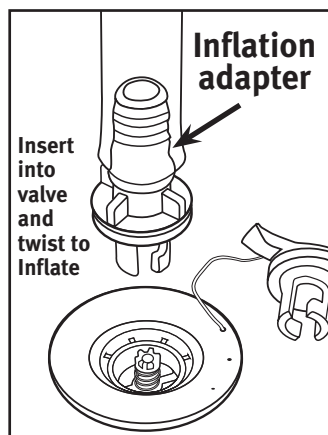
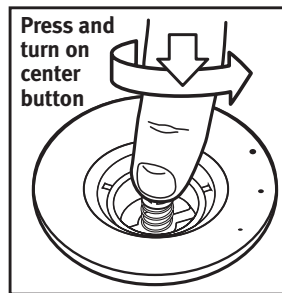
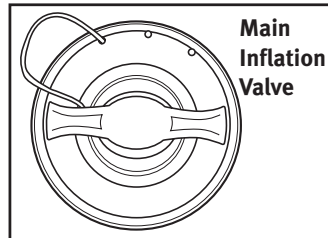

Inflate the main chamber in the pontoon to about 3/4 full. Do not inflate beyond 3/4 full because it will make the next step very difficult—attaching the pontoons to the frame.

Repeat this step with the other pontoon.

3. Attach the pontoons to the frames.

Each pontoon attaches to a metal pontoon frame with two webbing attachment straps.

Locate the left and right pontoon frames. On the front of each rail (where the front of the boat will be) there is a “L” (left) or “R” (right) label indicating left or right. Place a left pontoon frame on top of the left pontoon (remember—the left/right label is in the pocket) and a right pontoon frame on the right pontoon. The longest straight tube of each rail should be on the same side of the pontoon as the pontoon zipper.

Now attach the two webbing straps on the pontoon to the pontoon frame. Thread the straps as follows:

- Under outside frame, over frame, through ring, over frame...
- Over to the other side, under inside frame, through ring, under frame again, over frame, through cam buckle, over frame...

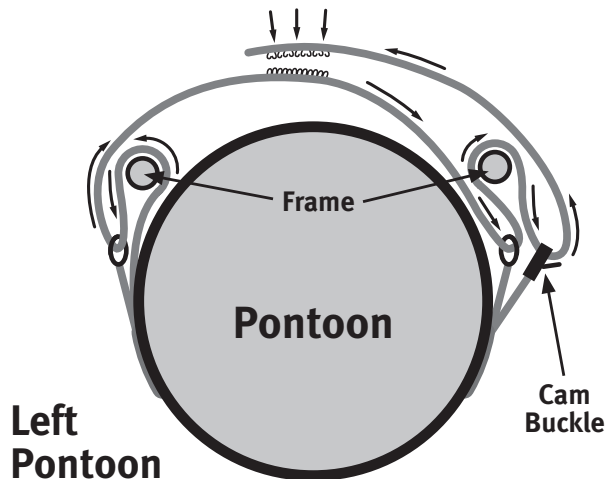

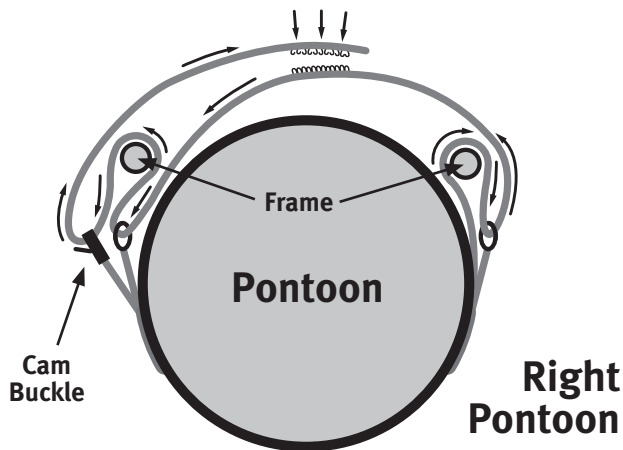

- Over the top and match hook and loop straps with each other.
- Adjust fit with cam buckle.

Repeat for the remaining strap then attach the other pontoon to its frame.

4. Inflate the pontoon completely.

Finish inflating the pontoons using both valves in each pontoon as outlined in Step 3. **Inflate to approximately 2.5 psi (0.17 BAR). Inflate until firm but not hard. Do not over inflate.**

5. Assemble the seat base and seat frame.

Locate the seat base and seat frame. **You must SIMULTANEOUSLY insert all four posts of the seat base into the seat frame posts. A small quantity of lubricant applied to the inside of the seat frame receptacle posts with a paper towel will greatly ease this step.**

Place the seat frame on the ground with the open ends of the four small posts facing up. Now place (do not yet insert) the four small posts of the seat platform over the seat frame posts as shown.

With the seat platform posts leaning in, **slightly**

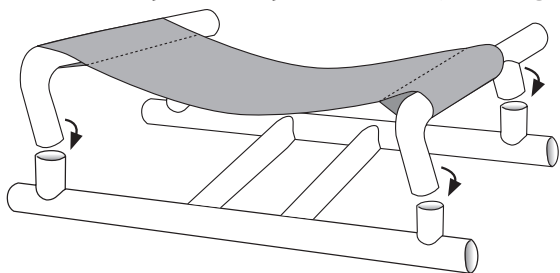

press in all four of the seat frame receptacle posts, then put your full weight evenly across both seat platform rails and press them all the way down.

If you can't press the seat platform into the seat frame you can turn the assembly upside down (so that the fabric is on the ground) and stand on the seat rails. You can also use a rubber mallet.

6. Attach the seat frame to the pontoon frames.

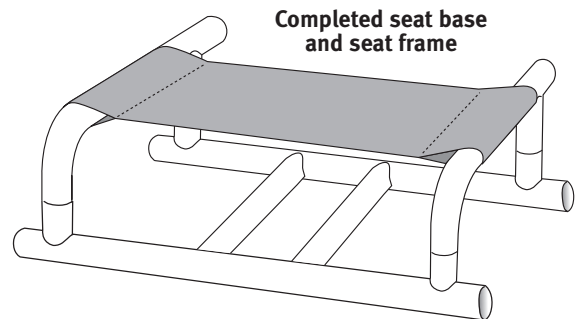

Locate the seat base and find the curved legs. With the curved legs to the front, insert the seat platform rails onto the pontoon frame posts. (The front of the pontoon frames are the ends labeled "L" and "R").

Now insert four of the short clevis frame pins from the top down into the holes where the four seat platform rails slide onto the pontoon frame posts. Each wire security retainer must go over the seat frame rail and then over the clevis pin as shown.

You MUST lock the security retainers on all four clevis pins to insure that the frame stays together.

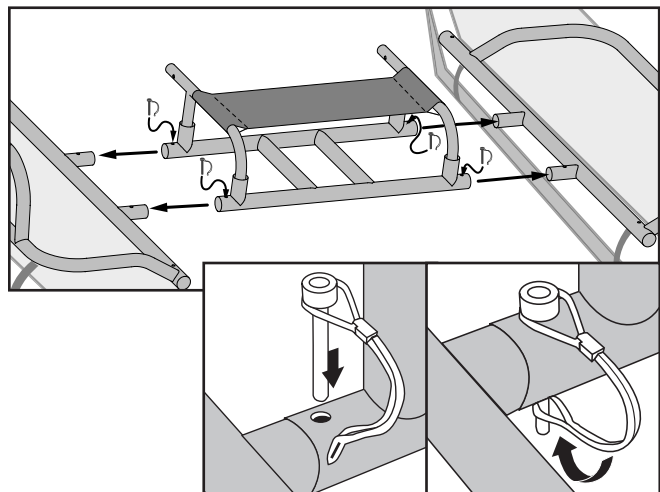

7. Insert the foot pegs.

Locate the front of the pontoon frames, (the end closest to the oar lock). Insert the foot pegs into the pontoon frame and attach with short clevis pins. Choose a position in the middle of the adjustment range.

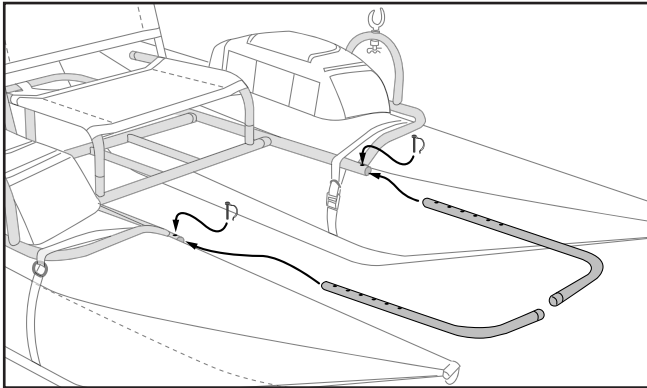

Now attach webbing straps over the frame, through the square ring and secure with the hook and loop straps. Some adjustment may be necessary to center the fabric deck on the frame.

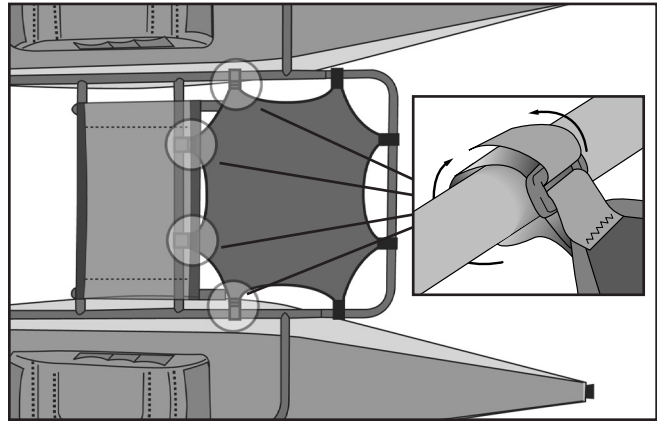

8. Attach the cargo deck.

The cargo deck comes partially assembled to the rear of the deck frame. Start by inserting the front of the cargo deck frame into pontoon

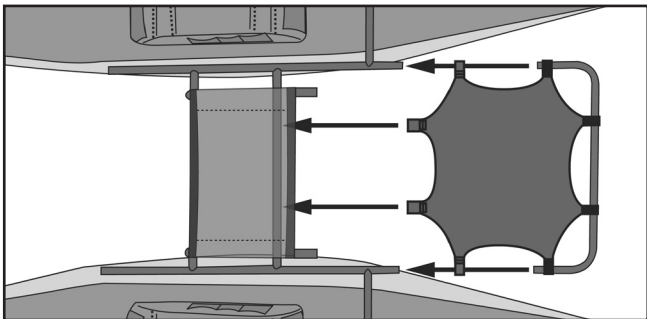

frames. Insert a short clevis frame pin on either side of the frame from the top down into the holes where the cargo deck frame slides into the pontoon frames.

9. Secure the seat back into place.

Slide the seat stubs onto each end of the seat back frame. Next, slide the seat back panel onto the seat back frame. Then place the assembled seat back into position on the outsides of the seat frame and secure to the seat base with the two long clevis frame pins.

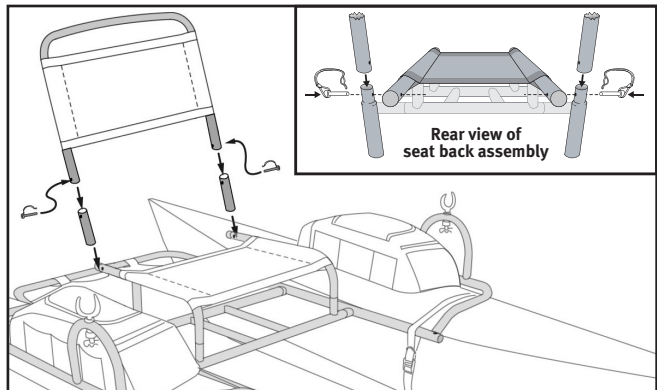

10. Attach the stripping apron.

Orient the stripping apron in front of and under the seat as shown. Attach the straps on the front corners of the apron, around the frame, through the square ring and over the hook and loop straps.

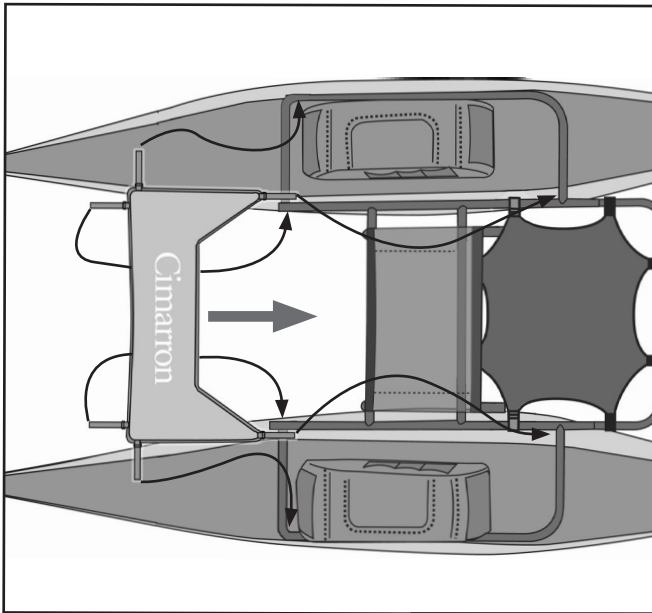

11. Do the first fitting.

Sit in the boat and adjust the length of the foot pegs. (Many people find the most comfortable position is to have their knees slightly bent.)

You can also move the platform forward or back slightly on the pontoons by loosening and tightening the pontoon webbing attachment straps.

The goal is to find your balance point. When you are floating in the boat it should be level in the water.

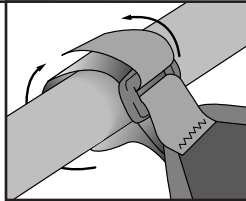

12. Assemble the oars.

First assemble the two piece oars.

Then remove the cotter pins from the oar locks attached to the upper part of the oars and slide the oarlocks into the brackets on the frame.

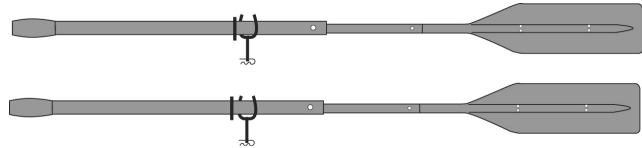

Then adjust the rubber oar stops evenly on both oars for optimum rowing position.

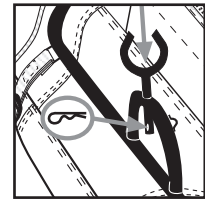

13. The bladder repair kit.

Included with your boat are self-adhesive tube patches to repair any tears or holes in the pontoon bladders. We recommend storing these in one of the pockets to keep it available for repairs.

14. Do the final fitting and adjustments.

Sit in the boat on dry land and adjust the foot pegs and oar lock placement to your leg length and preference.

Float your Cimarron Pontoon Boat in shallow water. Push off, get seated comfortably, place your feet on the foot pegs and check to see if you are level in the water. (This is easier with a another person on shore). **The goal is to find your balance point. When you are floating in the boat it should be level in the water.**

Placing heavy cargo on the cargo deck may necessitate moving the seat forward.

If you need to adjust the seat or foot pegs bring the boat back to shore and make the needed adjustments.

Practice going forward and backward a bit to get comfortable. Then catch some fish and enjoy your boat!

REPAIR & TROUBLESHOOTING

Repairing Tears and Holes in Pontoon Bladders

If your pontoon bladder becomes torn or punctured, use the enclosed patches to fix it. It may be necessary to take the pontoon bladder out of the pontoon skin. Look in the Troubleshooting section on the next page for this procedure. To fix a hole or tear, follow the steps listed below.

1. For best results, it is important to apply patch to a clean, dry surface and that the surface temperature is 50° F (10° C) or warmer.
2. Use an alcohol prep pad to clean the surface to be repaired. If you do not have an alcohol prep pad, use a 50/50 mixture of isopropyl alcohol and water. After cleaning, allow the surface to dry completely.
3. Cut a patch to the correct size with scissors. Allow for the patch size to extend one inch beyond all edges of the tear. Cut the patch with rounded corners. This will make it difficult for the corners to peel up after it is attached.
4. Peel back 1/8 in - 1/4 in (0.3 cm - 0.6 cm) of paper backing and position and anchor the exposed patch edge, allowing the patch to extend 1 inch beyond all edges of the tear.
5. Slowly peel the paper backing while carefully applying the patch over the tear. Take care to avoid air bubbles.
6. Rub the patch firmly for proper adhesion and allow to cure for 4 hours before use.

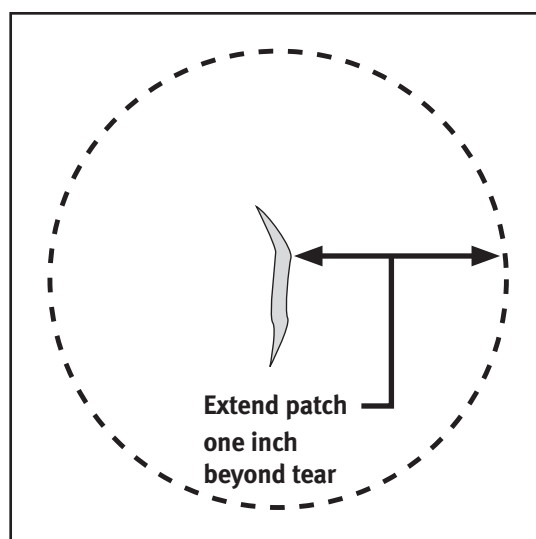

REPAIR & TROUBLESHOOTING

If your boat appears to be losing air, it might not be because of a leak. Changes in air temperature, elevation and use on cold water (which can cool the air inside the pontoon bladders) can all have an effect on the air inside the bladders. If none of these factors have changed, you may need to look for a leak. Follow the steps listed below.

1. Start by giving the pontoon skins a visual inspection.
Is the pontoon skin ripped or torn? Are there any major scuff marks?
If so, it might be an indication of a bladder tear or leak.

2. Check if you can hear air escaping the bladder in any suspected areas. You can apply soapy water to any suspected areas as well. A leak will produce bubbles.
If you find a hole, fix it using the methods listed earlier in these instructions.

If you don't find a leak using these methods, check the inflation valves:

3. Give them a visual inspection, making sure the valve is closing properly and the valve cap closes securely.
4. Check if you can hear air escaping. You may also use soapy water around the valve. If you find that a valve is leaking air around its edge, the valve may be loose.

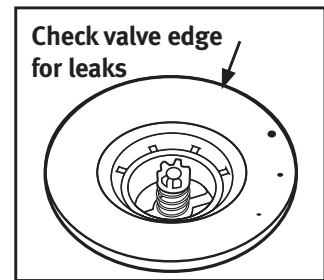

Checking For A Leaking Valve

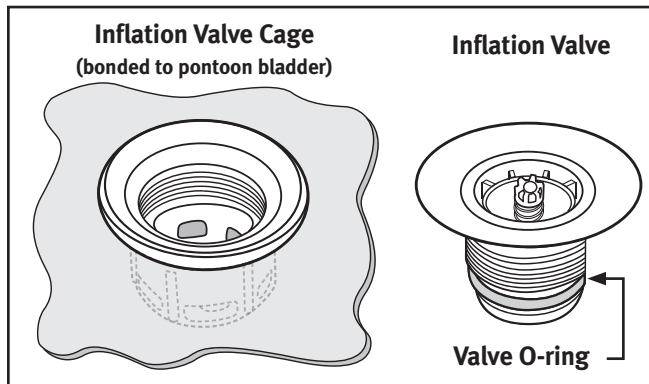

The inflation valve consists of a two-part assembly. There is the inflation valve itself and the inflation valve cage. The inflation valve cage protects the inflation valve from damage and is bonded into the pontoon bladder.

To tighten a loose valve insert the Inflation Valve Wrench into the valve and twist clockwise. It may be necessary to grasp the inflation valve cage (which is inside the pontoon bladder) to get enough purchase

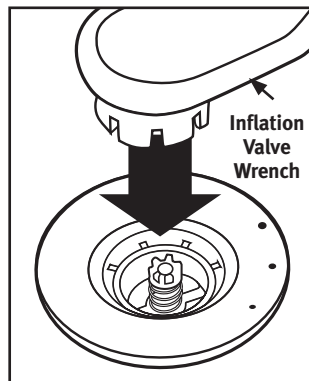

to twist the valve. Be careful not to tear or rip the bladder skin.

If the valve is difficult to turn, remove the valve completely and add a small amount of silicon grease to the valve O-ring and reassemble.

If the valve is not leaking around its edge, you may have a defective valve.

Please visit our website at the web address listed on the last page of these instructions to order a new valve.

If you must remove the pontoon bladder from the pontoon skin to make a repair, you must completely unscrew the inflation valve from the inflation valve cage. Make sure to align the valves in the bladder with the valve openings in the skin. Since the pontoon skin is captive in between the inflation valve cage and the inflation valve, care must be taken not to tear, rip or stress either the bladder or the skin by over-tightening the valve.

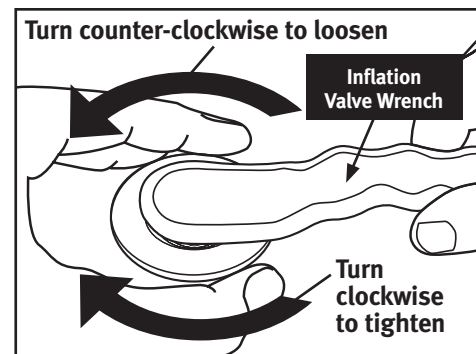

CARE & STORAGE

TRANSPORTING YOUR PONTOON BOAT

The Boat can be transported partially or fully assembled and or inflated. Due to size constraints, many customers will keep their frame fully intact and simply inflate and attach their pontoons once they reach their destination. Various methods such as a pickup truck bed, trailer, or roof rack can be used to transport your boat. If you are carrying a partially or fully assembled and or inflated boat, please consult with your vehicle, trailer, or roof rack Manufacturer.

CARE FOR YOUR BOAT

The pontoon boat can be cleaned with soap and water then rinsed. Use a soft rag for hard to clean areas.

SEASONAL STORAGE OF YOUR BOAT

Remove pontoons from the frame, empty pockets of any sharp objects that may puncture the skin. Deflate completely and fold for storage. Store pontoons away from sharp objects, heat or abrasive wear. Dismantle frame and boat parts and store in box.

ADDITIONAL PARTS

May be purchased on line at: www.classicaccessories.com

CLEAN ANGLER STATEMENT

Classic Accessories is a proud partner of the Federation of Fly Fishers Clean Angler program. We invite you join us in our efforts to keep your favorite waterways free of invasive, non-native species that can seriously damage them.

We encourage you to visit www.cleanangling.org and take the Clean Angler pledge.



(This page left blank)

(This page left blank)

WARRANTY

One Year Limited Warranty

If the boat, oars, backpack or pump fail due to a defect in workmanship and materials within one year from the date of purchase Classic Accessories will repair or replace it free of charge. This warranty gives you specific rights and you may also have other rights which vary from state to state.



22640 68th Ave. S. Tel: (253)395-3900
Kent, WA, USA 98032 Fax: (253)395-3991
www.classicaccessories.com
Email: customerservice@classicaccessories.com



CLASSIC[™]
ACCESSORIES

We Cover Your Gear®