



The Colorado

Pontoon Boat

O W N E R ' S M A N U A L



TABLE OF CONTENTS

INTRODUCTION	3
SAFETY INFORMATION AND SYMBOLS	4
RESPONSIBILITIES OF THE OPERATOR(S)	5
PRODUCT SPECIFICATIONS & CAPACITY	6
INFLATION	7
ELECTRIC MOTOR AND BATTERY USE	8
PARTS LIST	10
ASSEMBLY AND USE	11-16
REPAIR AND TROUBLESHOOTING	18-19
WARRANTY	20

INTRODUCTION

Congratulations on your purchase of a Classic Accessories pontoon boat.

This manual has been compiled to help you assemble your boat correctly and operate it safely. It contains specific details of the boat, including its parts and equipment, and information on its safe operation, proper care, maintenance and repair. Please read it carefully, and familiarize yourself with your boat before using it.

If this is your first pontoon boat, or if you are changing to this type of boat for the first time, for your own comfort and safety, please ensure that you obtain handling and operating experience before serious use. Doing so will assure many years of trouble free use and enjoyment.

PLEASE KEEP THESE INSTRUCTIONS IN A SECURE PLACE, AND TRANSFER THEM TO THE NEW OWNER IF YOU SELL THE CRAFT.

MODIFICATIONS

Because of possible interference with the factory design and integrity of the boat, owner modifications to the boat, any of its parts, equipment or systems are not recommended and will void the warranty.

Classic does not recommend that owners modify the boat or any of its parts, equipment or systems. Such modifications could compromise the design and integrity of the boat, prevent safe operation, and void warranty coverage.

SAFETY INFORMATION AND SYMBOLS

 The symbol to the left is the Safety Alert symbol. It is used to alert you to potential personal injury hazards. Obey all safety messages that follow this symbol to avoid possible injury or death.

DANGER

Indicates a potentially hazardous situation which, if not avoided, will result in death or serious injury.

WARNING

Indicates a potentially hazardous situation which, if not avoided, could result in death or serious injury.

CAUTION

Indicates a potentially hazardous situation which, if not avoided, may result in minor or moderate injury.

CAUTION

Indicates a potentially hazardous situation which, if not avoided, may result in property damage.

This manual lists certain recommended practices and provides some basic precautions. However, this list of precautions is not all-inclusive. Users must follow all applicable laws, rules, and regulations and should exercise appropriate caution in the safe operation of this pontoon boat.

REMEMBER - always exercise common sense when using your pontoon boat.

RESPONSIBILITIES OF THE OPERATOR(S)

IMPORTANT SAFETY INFORMATION

- Read this owner's manual carefully before using your pontoon boat.
- This is not a life saving device.
- You **MUST** wear an approved personal flotation device (PFD).
- All safety equipment & PFDs must properly fit the user, be in good condition, and suitable for your body weight.
- Know and follow all local water safety rules and boating regulations.
- Do not exceed 400 lbs. total weight. (The weight of you and all of your gear should not exceed 400 lbs.)
- Inspect your pontoon boat for wear or damage before and after each use.
- This product is not to be used by children under the age of 6 years of age or by any child without adult supervision. Check the laws in your state.
- Do not use under the influence of drugs or alcohol.
- Do not tow this pontoon boat.
- Use only in water free from debris and obstructions.
- Do not use in high wind, rapid currents, open water or dangerous tides.
- Seek shelter from water if there is threat of lightning.
- Do not stand on this product while in use.
- Never dive into or from this boat.
- Inflate with cold air only.
- Do not over inflate or use CO₂ or a high pressure air compressor to inflate.
- Follow the inflation sequence listed in this instruction manual.
- Recommended working pressure is 2.5 – 3.0 psi (0.17 bar).
- Check for leaks before using.
- Partially deflate if leaving boat in direct sunlight or within a vehicle in sunlight.
- Remember that air pressure changes with temperature and elevation so always check your air pressure before use.

PRODUCT SPECIFICATIONS & CAPACITY

BOAT SPECIFICATIONS

Product Name: COLORADO Pontoon Boat

Dimensions: 108L x 56 W x 28H (top of the seat)

Dry Weight: 77 lbs.

Maximum Persons Capacity: 1 person (up to 275 lbs)

Maximum Persons & Gear Capacity: 400 lbs (181 kg)

Recommended Inflation Pressure: 2.5 – 3.0 psi (0.17 BAR)

Maximum Motor Thrust: 30 lbs

Maximum Motor Shaft Length: 36

BOAT CAPACITY

The person/load capacity is partly dependent on proper seating and load distribution. Make sure that your load is distributed evenly and the seating position is such that, when afloat, the boat rides level in the water.

⚠ WARNING - DO NOT EXCEED THE MAXIMUM CAPACITY OF THIS BOAT UNDER ANY CIRCUMSTANCES.

MAXIMUM CAPACITIES



1 PERSON OR **275** LBS.

400 LBS PERSONS, GEAR

PRESSURE = 2.5 psi (main chambers)

MAX 30 LB THRUST MOTOR

MANUFACTURER: CLASSIC ACCESSORIES, INC.,
KENT, WA, USA 98032

1  +  = **181 kg**

 •  = 0.17 bar (main chambers)

INFLATION

PROPER INFLATION

During final inflation, inflate until most of the wrinkles in the fabric are gone and it feels firm to the touch, but DO NOT exceed 2.5 psi (0.17 bar) in the main air chambers.

CAUTION - DO NOT OVER INFLATE YOUR PONTOON BOAT

Water temperature and weather affect the air pressure in the boat. In cold weather your pontoon boat will lose some pressure because the air will contract. If this occurs, you may want to add more air.

In hot weather, the air will expand. You must let out some air to prevent the pontoons from failing from over pressure. Avoid exposing your pontoon boat to extreme temperatures (hot or cold).

CAUTION

On warm sunny days, keep the pontoon boat either in water or in shade (if kept inflated on land). This will decrease the risk of overexpansion of the pontoon chambers posed by rising temperatures, which can result in seam tears, delamination and pinholes.

Avoid asphalt, sand, pebbles or concrete in direct sunlight as they radiate high ground heat.

Also understand that changes in altitude will cause the air in the bladders to expand or contract. If traveling to higher elevation with the pontoon boat inflated, frequently check the pressure in the pontoons to avoid over pressure. If traveling to lower elevation you may have to add more air to maintain proper pressure in the pontoons.

 **WARNING - ALWAYS CHECK THE AIR PRESSURE IN THE PONTOONS BEFORE AND DURING EACH USE.**

ELECTRIC MOTOR AND BATTERY USE

USING A MOTOR WITH YOUR PONTOON BOAT

Clamp your motor to the motor mount provided on the rear of your boat and carefully follow the setup and safety instructions provided with your motor.

Using a motor and battery will affect the weight distribution on your boat. Before using your boat for the first time with a motor check and adjust your seat position and cargo so your boat rides level in the water.

⚠ WARNING - THIS PONTOON BOAT IS NOT RATED FOR USE WITH GASOLINE OR DIESEL OUTBOARD MOTORS.

⚠ WARNING - MAKE SURE TO FOLLOW ALL SAFETY INSTRUCTIONS AND PROCEDURES THAT CAME WITH YOUR ELECTRIC MOTOR.

IMPORTANT - A MAXIMUM ELECTRIC MOTOR SHAFT LENGTH OF 36" WITH A MAXIMUM THRUST OF 30 LBS IS RECOMMENDED.

USING A BATTERY WITH YOUR PONTOON BOAT

Be sure to secure your battery to the rear wire platform so that it will not move or tip during operation. For the best weight distribution we recommend placing the battery as close to the seat back (center of the boat) as possible.

⚠ WARNING - BATTERIES CAN LEAK POISONOUS GASES OR LIQUIDS OR EXPLODE. USE EXTREME CARE AND FOLLOW ALL SAFETY INSTRUCTIONS AND PROCEDURES THAT CAME WITH YOUR BATTERY.

⚠ WARNING - MAKE SURE THAT YOUR ENGINE AND BATTERY ARE SECURELY FASTENED TO YOUR PONTOON BOAT BEFORE AND DURING EACH USE.

⚠ WARNING - ONLY USE AN APPROVED MARINE BATTERY. USE PROPER SHIELDING TO PREVENT SHORT CIRCUITS.

ASSEMBLY

It is important to follow these instructions to successfully and safely assemble your Classic Accessories Pontoon Boat.

Please pay particular attention to the bold faced instructions and any information which has this  symbol next to it.

PARTS LIST

Tools Needed:

- Rubber Mallet
- 2 Adjustable Wrenches

Before you begin please unpack the carton and check that you have all your parts.

IMPORTANT: All small parts are inside the center pocket of one of the storage bags.

Hard Frame Parts:

- 2 Pontoon frames (left and right)

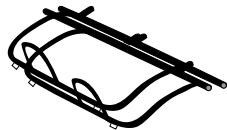

- 1 Seat frame

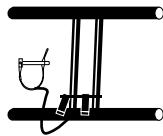

- 1 Seat (two piece with screws and wingnuts installed)

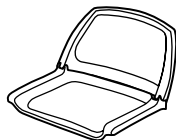

- 2 Foot pegs (left and right)

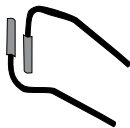

- 1 Rear platform frame

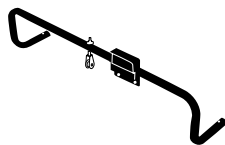

- 1 Rear cargo platform

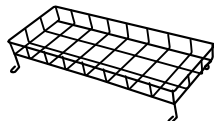

- 1 Rod holder with clevis pin



Soft Parts:

- 2 pontoons

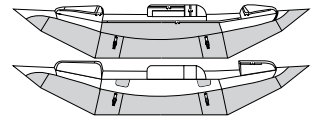

- 1 Under seat apron

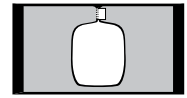

- 1 Anchor bag with cord



Miscellaneous Parts:

- 2 Pontoon bladder patches (Two 60mm self-adhesive patches)

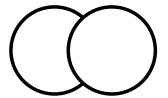

- 1 Inflation adapter

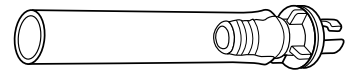

- 1 Inflation valve wrench



- 1 Allen wrench set (3mm, 4mm and 6mm ball end)



Frame Hardware Parts:

- 8 Frame clevis pins

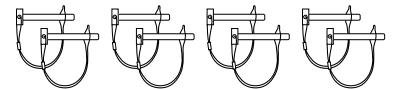

Oar Parts:

- 2 Oars (4 pieces or 2 per oar)

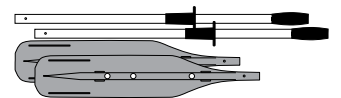

- 2 Oar locks



- 2 Oar lock cotter pins



ASSEMBLY AND USE

1. Confirm that all the parts are present.

(See the parts list on page 10).

2. Identify the right and left pontoons.

You can identify the right and left pontoons by the “R” and “L” labels sewn on the inside of the rear pocket on top of each.

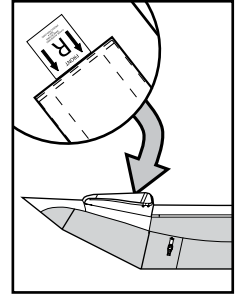

3. Partially inflate the air bladders.

The valve is located on the top and toward the front half of the pontoon.

The valve has a center button that opens and closes the valve by simply pushing down, and turning a quarter turn. The valve is open when the center button is down, and closed when it is up. **Before inflating, make sure the valve is in the closed position.**

Unscrew the valve cap, make sure the valve is closed and insert the inflation adapter into the valve and twist to secure. Inflate using a foot pump or air compressor with a cone-type nozzle fitting.

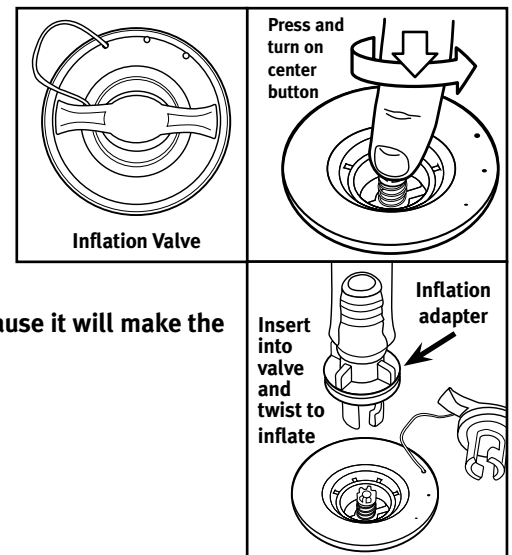

▲ Inflate the pontoon to about 3/4 full. Do not inflate beyond 3/4 full because it will make the next step very difficult—attaching the pontoons to the frame.

Repeat this step with the other pontoon.

4. Attach the pontoons to the frames.

Each pontoon attaches to a metal pontoon frame with four webbing attachment straps.

Locate the left and right pontoon frames.

On the front of each pontoon frame (where the front of the boat will be) there is a “L” or “R” label indicating left or right.

Place a right pontoon frame on top of the right pontoon as shown. (There is a “L” or “R” label inside the pocket of each pontoon). The longest straight tube of each frame should be on the same side of the pontoon as the pontoon zipper.

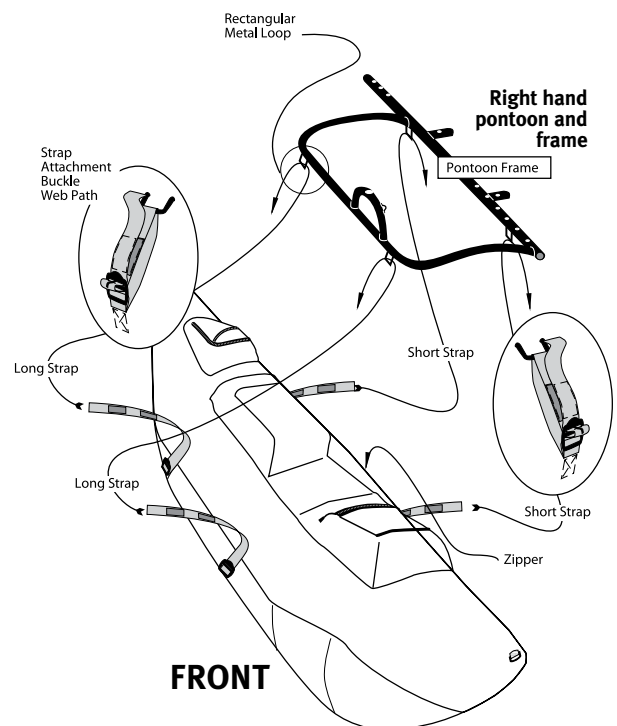

Now attach the two inside and two outside webbing straps on the pontoon to the pontoon frame. Thread the straps as follows:

1. Through the metal rectangle on the frame...
2. Back to the buckle...
3. Through the buckle threading path...
4. Match the rip-and-grip to each other.
5. Fold the remaining webbing. Back it through the metal rectangle and trap it between the pontoon and webbing. Repeat for the remaining three straps.

Repeat the procedure with the left pontoon.

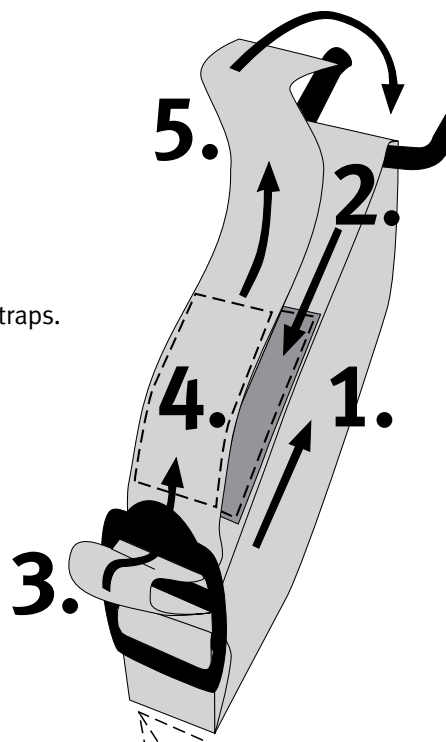

5. Inflate the pontoon completely.

Finish inflating the pontoons using both valves in each pontoon as outlined in Step 3.

▲ Inflate to approximately 2.5 psi. Inflate until firm but not hard. DO NOT over inflate.

6. Determine the seat placement.

The seat placement determines the center of gravity of the boat. Where you attach the seat to the frame depends on your size and whether you will be using a motor and battery or carry cargo on the boat.

Use the following information about seat placement as guide to help you setup your boat for optimum balance in the water. After setup, load your boat with the gear you would use fishing, and try your boat in shallow water to determine if further seat position adjustment is necessary for optimum weight distribution.

- If you are up to 5'6" in height, place the forward seat screws (underside of seat) into the front 1/3 of the seat frame bars.
- If you are up to 6' in height, place the forward seat screws (underside of seat) into the middle section of the seat frame bars.
- If you are over 6' in height, place the forward seat screws (underside of seat) into the rear 1/3 of the seat frame bars.
- If you use a motor and battery or load the cargo basket with any heavy items, you will need to adjust the seat forward to offset the load and keep your boat balanced. The amount you will need to move the seat forward depends on the weight of the cargo and will necessitate that you try out the new position in shallow water before setting out.
- Try making adjustments for cargo weight by moving seat forward in 1 increments.

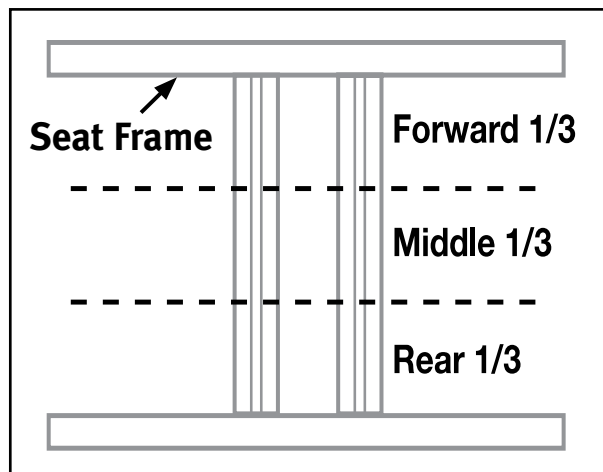

7. Attach the seat to the seat frame.

Locate the four 2" screws coming out of the bottom of the seat. Unscrew the wing nuts and remove the washers. Place the seat with screws facing downwards into the two bars on the seat frame and position the seat in the place that is best for your height and weight (see above). Once the seat placement has been determined, attach the washers and wing nuts onto the screws and tighten to hold the seat into place.

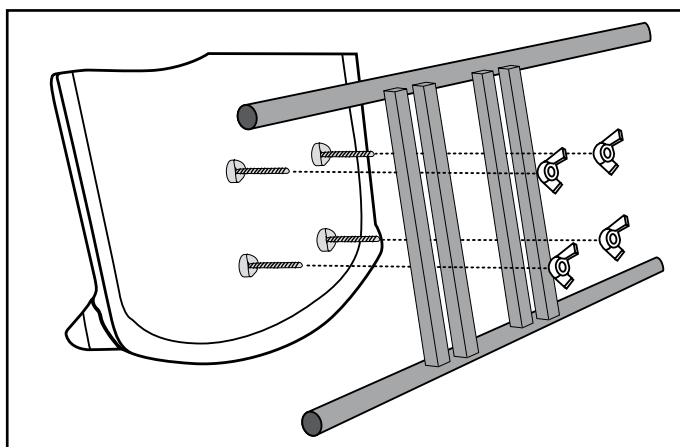

8. Attach the seat frame to the pontoon frames.

Insert the seat platform tubes onto the pontoon frame posts with the seat facing the front. (The front of the pontoon frames are the ends labeled “L” and “R”). (You may need to LIGHTLY tap the frames with a rubber mallet to fit).

Align the holes and secure with four clevis pins.

You MUST lock the security retainers on all four clevis pins to insure that the frame stays together.

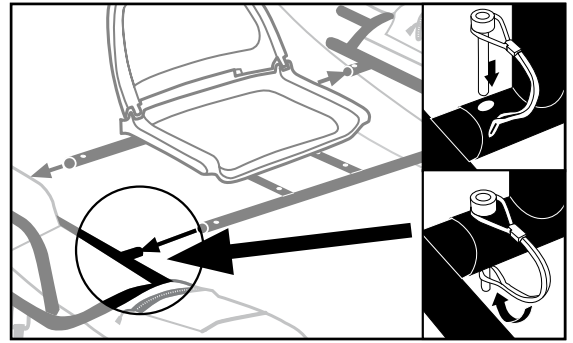

9. Thread the anchor bag cord.

Start by feeding the cord into the front anchor cord pulley located on the side of either pontoon frame. Continue by threading the cord through the cord guides and under all frame tubes.

Next, insert the cord through the rear cord tube guide [1] on the rear platform frame. Finish by threading the cord through the pulley mounted on the rear platform frame and attaching the cord to the anchor bag.

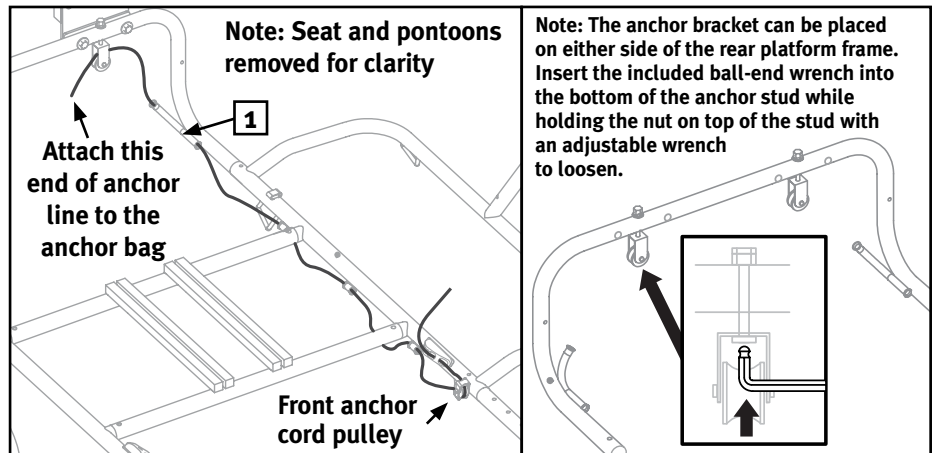

10. Attach the rear platform frame.

In order to attach the rear platform frame you must first partially attach the wire cargo deck. Start by sliding the bent wire tabs into the slots welded on to the rear of each pontoon frame.

Next, push the rear platform frame tubes into the open tubes on the rear of each pontoon frame. Make sure to insert the wire guides on the rear of the wire cargo deck into the corresponding holes on the rear platform frame as you push the tubes together. Also make sure not to pinch the threaded anchor cord.

Attach the rear corners with two clevis pins. These secure the wire cargo deck and the rear platform frame to the pontoon frames. Be sure to insert each pin through the cargo deck, the rear platform frame and through the pontoon frames. Lock both clevis pins.

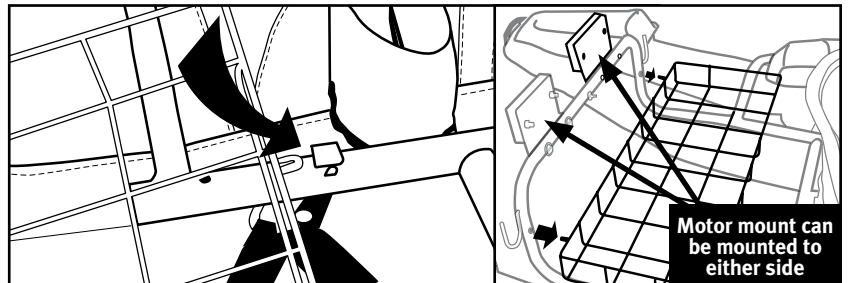

11. Insert the oar locks.

Insert an oar lock into the top of both oar lock brackets on the pontoon frames. There are three oar lock positions; we suggest starting with the forward most position. If you have the seat set back you may prefer the middle or back position. Secure each oar lock with an oar lock clevis pin.

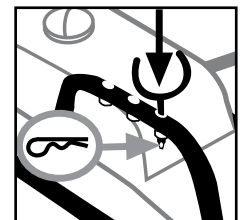

12. Insert the foot pegs.

Insert the foot pegs into the pontoon frame as shown. Starting with a position in the middle of the adjustment range, align the holes and secure with two clevis pins.

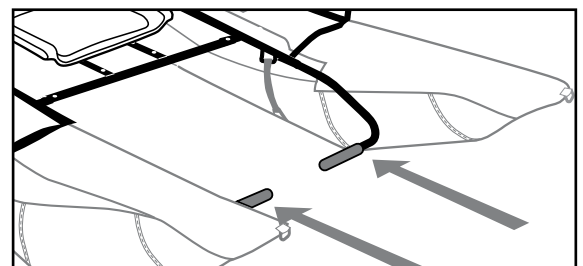

13. Attach the under seat apron.

The under seat apron has a rip-and-grip tab opening on one side. This allows for installation. Install with this tab facing up and to the rear of working from the front, fit the apron seat hole around the bottom of the seat. Reattach the rip-and-grip tabs at the back of the apron.

To secure, wrap the rip-and-grip tabs around the pontoon frames at the positions indicated by the arrows in the drawing above. Finish by hooking the four elastic shock cords on the back of the apron to the wire cargo rack.

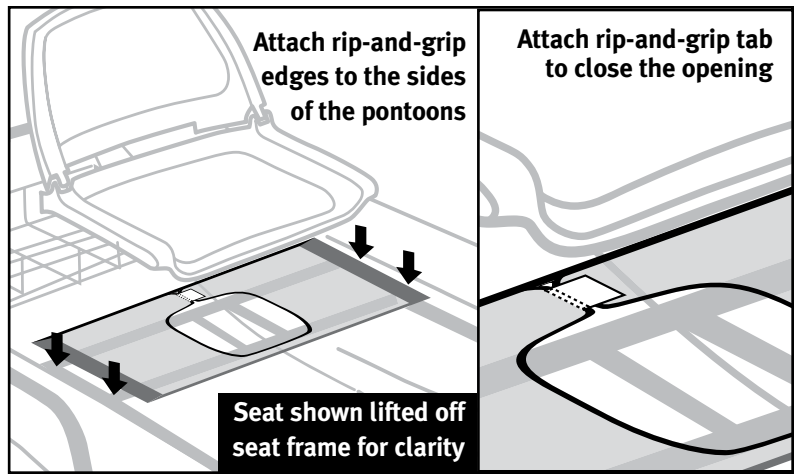

14. Set up the oars and oar stops.

First, assemble the two piece oars. Align the holes so that the button pops through the oar handle.

To set an oar in an oar lock drop the thinnest section of the oar into the oar lock. Slide the oar until the oar stop rests against the oar lock. The oar stops are adjustable if desired.

You will find oar rests at the back of the pontoons. These are useful for keeping the oars up and out of the way when they're not needed.

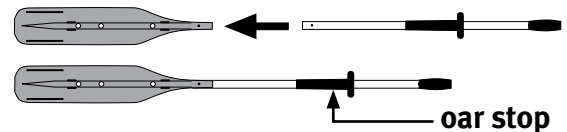

15. Attach the anchor system.

The anchor system consists of a mesh weight bag and a length of cord threaded through the frame (step 9).

The bag is filled with rocks or metal weights (not included). Usually six to eight lbs. will keep you anchored in a light breeze but the weight needed will vary depending on your weight, your cargo weight, currents and wind.

There are built-in cleats on the inside of each pontoon frame behind the front anchor cord pulley. Thread the cord around the front anchor cord pulley and back to the cleat. Thread the cord in the front and out the back of each cleat. To cleat the cord while anchoring, simply pull the cord into the jaws of the cleat. Pull up and away from the cleat jaws to release.

If the anchor cord cleat or the anchor cord pulleys ever loosen, use the included allen wrenches to tighten.

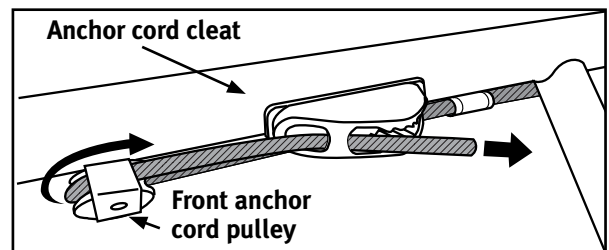

16. Attach the rod holder.

The rod holder may be placed in three different positions on either the left or right oar lock frame. You can hold your rod to the back (1), out to the side (2) or to the front (3). The rod holder attaches with the clevis frame pins as in step 8.

To use the rod holder first unwrap the rip-and-grip strap on the end. Put your rod in the holder butt end first then turn it to drop the reel handle into the cutout on the side of the rod holder. **Keeping one hand on your rod use your other hand to wrap the strap around the front of the reel to secure your rod in place in the holder.**

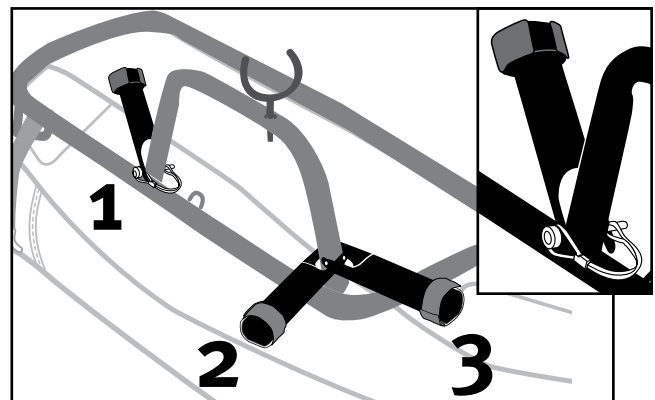

17. The bladder repair kit.

Included with your boat are self-adhesive tube patches to repair any tears or holes in the pontoon bladders. We recommend storing these in one of the pockets to keep them available for repairs.

18. Do the final fitting and adjustments.

Sit in the boat on dry land and adjust the foot pegs and oar lock placement to your leg length and preference.

Float your pontoon boat in shallow water. Push off, get seated comfortably, place your feet on the foot pegs and check to see if you are level in the water. (This is easier with a another person on shore).

⚠ WARNING - The goal is to find your balance point. When you are floating in the boat it should be level in the water.

⚠ WARNING - Using a motor and battery or placing heavy cargo in the wire cargo deck may necessitate moving the seat forward.

⚠ WARNING - If you need to adjust the seat or foot pegs bring the boat back to shore and make the needed adjustments.

**⚠ WARNING - DO NOT STAND UP IN YOUR BOAT WHILE ON THE WATER.
YOU COULD LOOSE YOUR BALANCE AND FALL OVERBOARD.**

Practice going forward and backward a bit to get comfortable. Then catch some fish and enjoy your boat!

CLEAN ANGLER STATEMENT

Classic Accessories is a proud partner of the Federation of Fly Fishers Clean Angler program. We invite you join us in our efforts to keep your favorite waterways free of invasive, non-native species that can seriously damage them.

We encourage you to visit www.cleanangling.org and take the Clean Angler pledge.



REPAIR & TROUBLESHOOTING

Repairing Tears and Holes in Pontoon Bladders

If your pontoon bladder becomes torn or punctured, use the enclosed patches to fix it. It may be necessary to take the pontoon bladder out of the pontoon skin. Look in the Troubleshooting section on the next page for this procedure. To fix a hole or tear, follow the steps listed below.

1. For best results, it is important to apply patch to a clean, dry surface and that the surface temperature is 50° F or warmer.
2. Use an alcohol prep pad to clean the surface to be repaired. If you do not have an alcohol prep pad, use a 50/50 mixture of isopropyl alcohol and water. After cleaning, allow the surface to dry completely.
3. Cut a patch to the correct size with scissors. Allow for the patch size to extend one inch beyond all edges of the tear. Cut the patch with rounded corners. This will make it difficult for the corners to peel up after it is attached.
4. Peel back 1/8"-1/4" of paper backing and position and anchor the exposed patch edge, allowing the patch to extend 1 inch beyond all edges of the tear.
5. Slowly peel the paper backing while carefully applying the patch over the tear. Take care to avoid air bubbles.
6. Rub the patch firmly for proper adhesion and allow to cure for 4 hours before use.

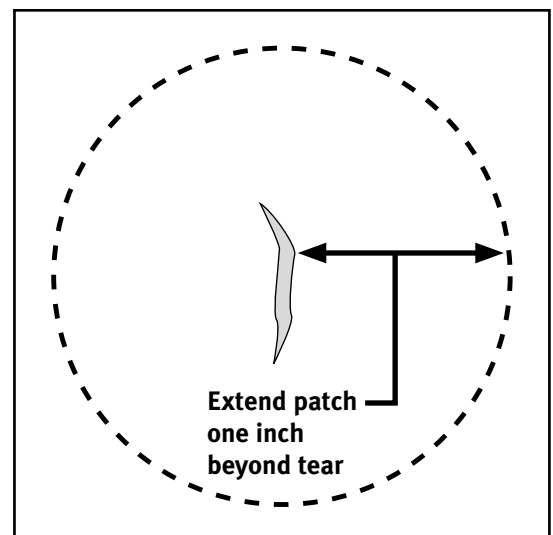

TROUBLESHOOTING

If your boat appears to be losing air, it might not be because of a leak. Changes in air temperature, elevation and use on cold water (which can cool the air inside the pontoon bladders) can all have an effect on the air inside the bladders. If none of these factors have changed, you may need to look for a leak. Follow the steps listed below.

1. Start by giving the pontoon skins a visual inspection.
Is the pontoon skin ripped or torn? Are there any major scuff marks?
If so, it might be an indication of a bladder tear or leak.
2. Check if you can hear air escaping the bladder in any suspected areas. You can apply soapy water to any suspected areas as well. A leak will produce bubbles.
If you find a hole, fix it using the methods listed earlier in these instructions.

If you don't find a leak using these methods, check the inflation valves:

3. Give them a visual inspection, making sure the valve is closing properly and the valve cap closes securely.
4. Check if you can hear air escaping. You may also use soapy water around the valve. If you find that a valve is leaking air around its edge, the valve may be loose.

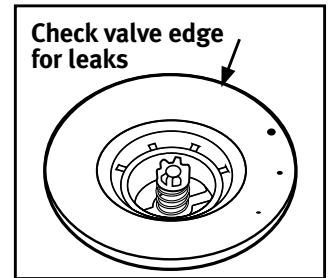

Checking For A Leaking Valve

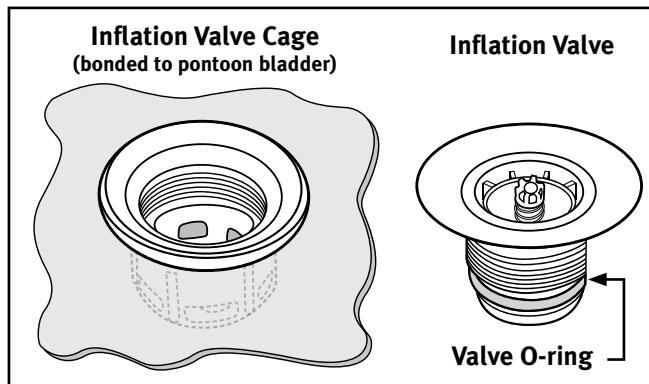

The inflation valve consists of a two-part assembly. There is the inflation valve itself and the inflation valve cage. The inflation valve cage protects the inflation valve from damage and is bonded into the pontoon bladder.

To tighten a loose valve insert the Inflation Valve Wrench into the valve and twist clockwise. It may be necessary to grasp the inflation valve cage (which is inside the pontoon bladder) to get enough purchase to twist the valve. Be careful not to tear or rip the bladder skin.

If the valve is difficult to turn, remove the valve completely and add a small

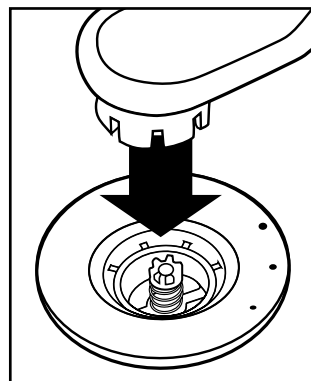

amount of silicon grease to the valve O-ring and reassemble.

If the valve is not leaking around its edge, you may have a defective valve.

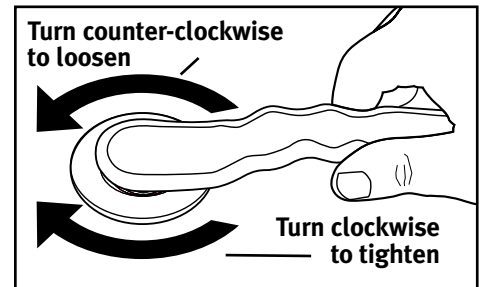

Please visit our website at the web address listed on the last page of these instructions to order a new valve.

If you must remove the pontoon bladder from the pontoon skin to make a repair, you must completely unscrew the inflation valve from the inflation valve cage. Make sure to align the valves in the bladder with the valve openings in the skin. Since the pontoon skin is captive in between the inflation valve cage and the inflation valve, care must be taken not to tear, rip or stress either the bladder or the skin by over-tightening the valve.

WARRANTY

Two Year Limited Warranty

If this boat fails due to a defect in workmanship and materials within two years from the date of purchase Classic Accessories will repair or replace it free of charge. Inflating the pontoons without the inflation adaptor will invalidate this warranty. This warranty gives you specific rights and you may also have other rights which vary from state to state.



22640 68th Ave. S.
Kent, WA, USA 98032
www.classicaccessories.com
Email: customerservice@classicaccessories.com

Tel: (253) 395-3900
Fax: (253) 395-3991

 **CLASSIC**
ACCESSORIES
We Cover Your Gear®

©2008 Designed in the U.S.A.
07cF58_004 69664